

# Exclusive Doors

GERMAN  ENGINEERED



With over 8 years of experience, **Projetta by Weiku** is a pioneer in the manufacture of ACM (compound aluminum) doors, taking its products to the four corners of Brazil and the world.

The passion for designing and developing doors is a force that drives the search for new solutions, trends, technology, and design, placing the company at the forefront of the market.

The use of state-of-the-art and extremely precise equipment means that impeccable finishes are produced on doors that demand a high standard in every detail.

The special sized doors manufactured by **Projetta by Weiku** have a double sealing system, ensuring total impermeability around the entire perimeter of the door. This is possible thanks to the use of Q-LON technology, an imported high-performance material, present in the main frames in the world.

#### **Our mission**

To expand the ACM door market in Brazil and take our products to the four corners of the world.

#### **Our vision**

To always stay ahead, being a reference in the world market in aluminum doors - presenting new products, variety of models, quality and technology.

#### **Our values**

Transparency, innovation, creativity and quality.

Passion for  
developing  
products with  
technology  
and high  
standard in  
every detail.

**FELIPE XAVIER**  
Founder and Director of Projetta



# Projetta ALUMINUM

We are waiting for you!

Our products are installed in Brazil and in several countries around the world.

## South America

Argentina  
Brazil

## North America

Canada  
USA  
Mexico

## Central America

Aruba  
Haiti  
Jamaica  
Dominican Republic

## Europe

Belgium  
France  
Netherlands  
North Macedonia  
Switzerland

## Middle East

Bahrain  
United Arab Emirates  
Kuwait  
Oman  
Qatar

## Africa

Senegal  
Sierra Leone

## Australia & Oceania

Australia

## South Asia

Pakistan



**ARND E. KILIAN**  
Weiku Founder and Director

# Your EXCLUSIVE DOOR

## Models of doors

- With external handles (see page 10).
- With pocket handles (see page 13).



## Serial items from your door

- Semi-Gloss colors (see page 27).
- Metallised colors (see page 28).
- 100% aluminum door skin structure with reinforced profiles.
- 4mm thick ACM sheet (inner and outer) with PVDF Topcoat 70% and 0.3mm aluminum foil (inner and outer). Further information about ACM (see page 26).
- Doorstop with system for leveling fit (see availability of use of casing).
- Pivot in stainless steel 304 with ball and bearings for loads from 150 to 1000 kg.
- Double auto-seal (eliminates top and bottom crevices).
- Q-LON across the entire height of the skin and portal (eliminates side crevices).
- Security lock from 4 to 24 locking points (depending on door size).
- 3 keys with computer encoding.
- External handle (Black, Polished or Brushed) 1500 mm.

## Available accessories (price upon request)

- Stainless steel 304 handles from 1500 to 5000 mm.
- Digital locks (Smart Lock).
- Spy hole.
- Pivot with Soft Close (Fritsjurgens).

## Available Colors (price upon request)

- Solid colors (see page 27).
- Wooden / Special colors (see page 29).



# Pivot DOORS

## Getting to know the product and its advantages

Used in Brazil for over 20 years, the doors with a pivot system are ideal to be installed at the entrance of houses or apartments - adding aesthetics and elegance to any type of design. In this system, a part of the door is designed for the exterior and another for the interior, which allows the choice of larger models, with a modern and bold design.

One of the great advantages of swing doors is that all their weight is on the lower pivot. Thus, the weight limitation existing in the traditional system, which uses hinges, is eliminated. In addition to its elegant axle system, the pivot system is built into the portal and attached to the bottom and top of the door, hiding the hardware and providing a more modern look - different from the traditional system where the hinges are visible.

Pivot doors are also easier to install compared to traditional doors. The existence of two support pivots provides a perfect fit for the doors. The higher your door, the greater the feeling of space given to the environment.

The internal structure of the doors is all aluminum - noble material, light and resistant. The accessories are manufactured in 304 stainless steel (screws, pivoting system and locks) making the doors resistant to sun, rain, rust and weathering.

## What are the main benefits?

- 100% aluminum structure.
- External coating 100% in ACM.
- Seal around the perimeter of the door.
- Upper and lower automatic sealing system.
- Resistant to sun and rain.
- Painting warranty of up to 15 years.
- Low maintenance.
- Modern design.
- Accessories made of stainless steel 304.
- High technology and durability.

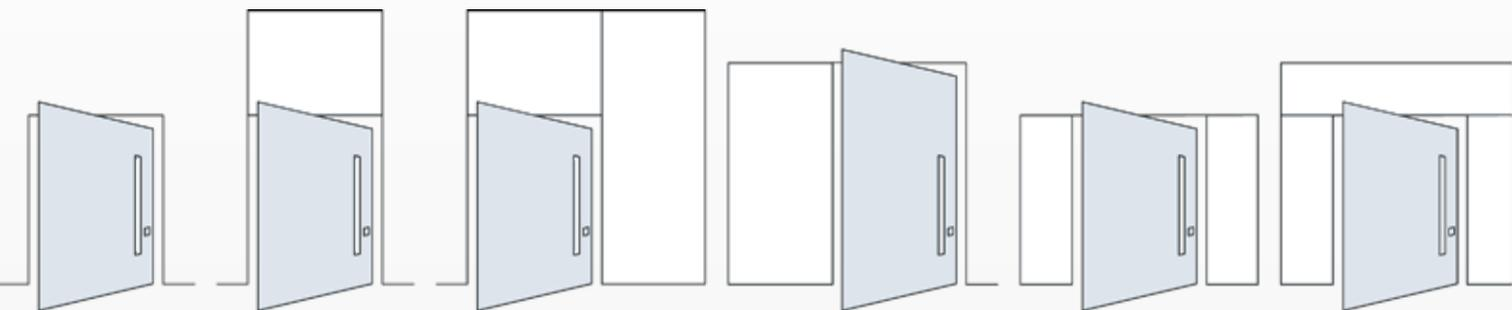

# Pivot SYSTEM

## Functioning characteristics

In the pivoting system, the doorskin rotates around a vertical axis (the pivot) instead of hinges (traditional system). The fastening pins are placed above and below the doorstop, ensuring greater lightness and flexibility to the door.

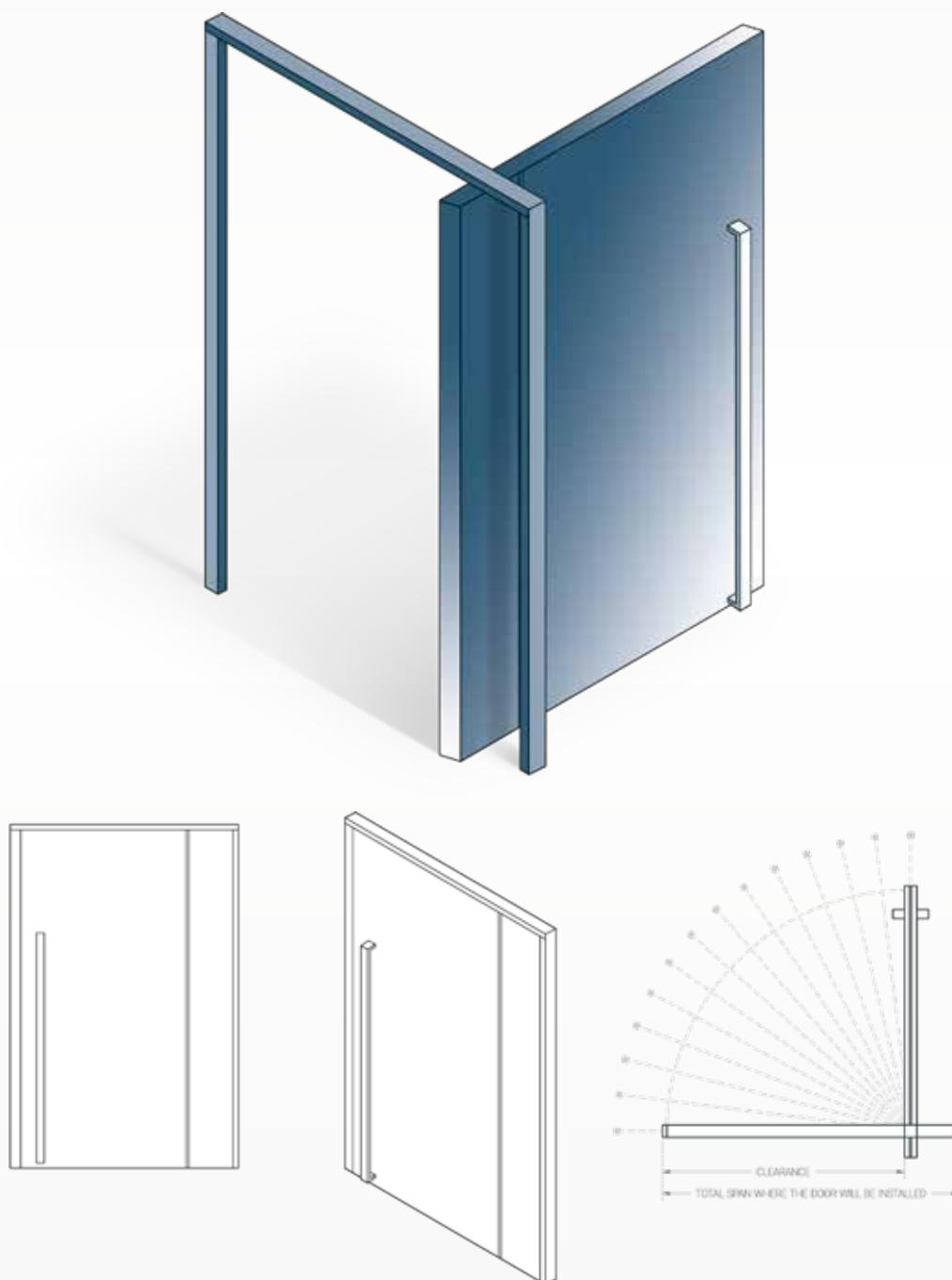

**NOTE:** Check the clearance according to the total span where the door will be installed.

# Our EXTREMES

## Product sizes

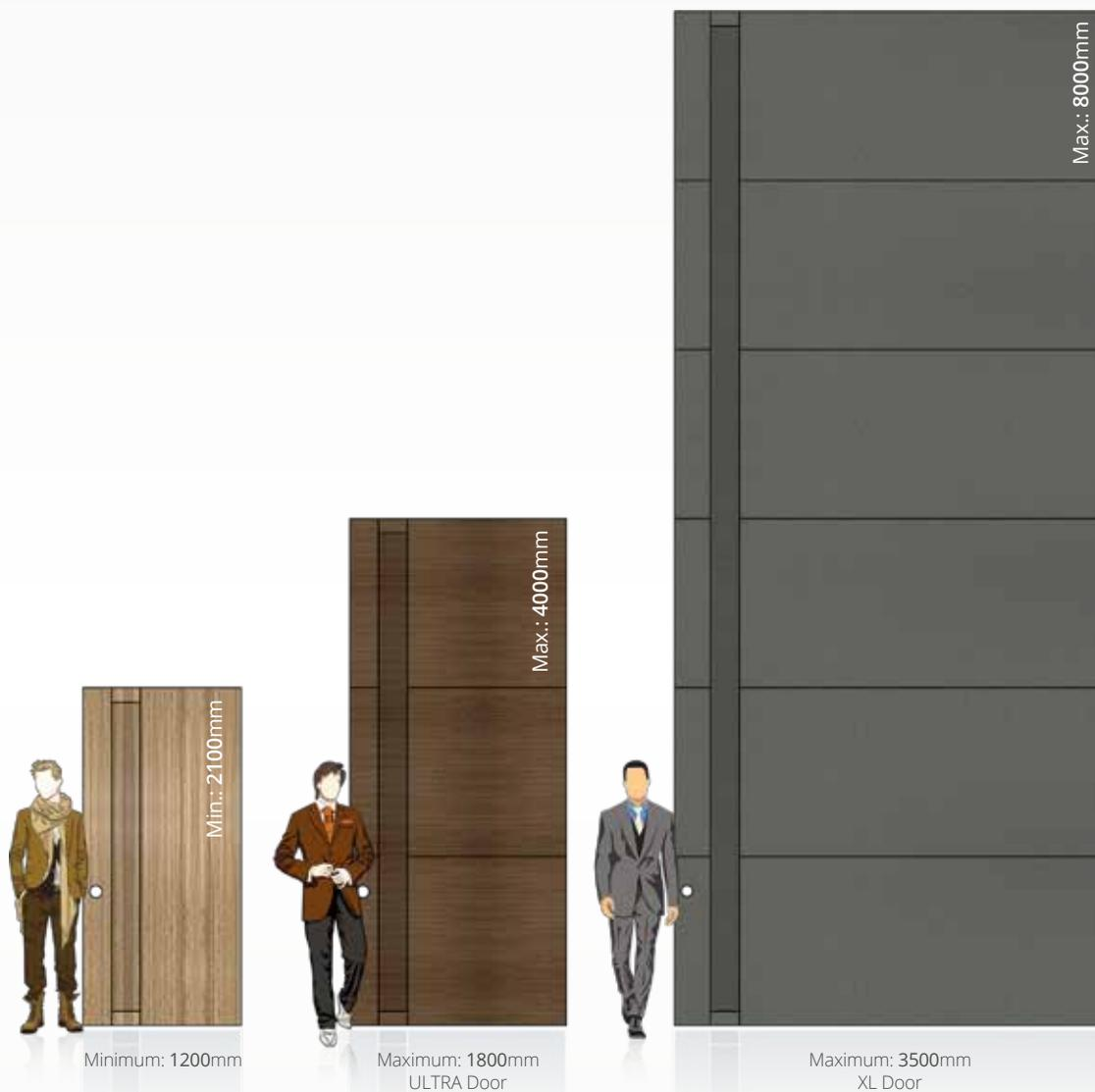

### Doors **ULTRA DOOR**

The maximum measurement of 1800 x 4000 mm of opening may be reached on a single skin. ULTRA Doors reach a maximum thickness of 100 mm and their pivot system supports up to 250 kg.

### Doors **XL DOOR**

The maximum measurement of 3500 x 8000 mm of opening may be reached on a single skin. XL Doors reach a maximum thickness of 120 mm and their pivot system supports up to 1000 kg.

# Doorstop system CASING

## System with casing

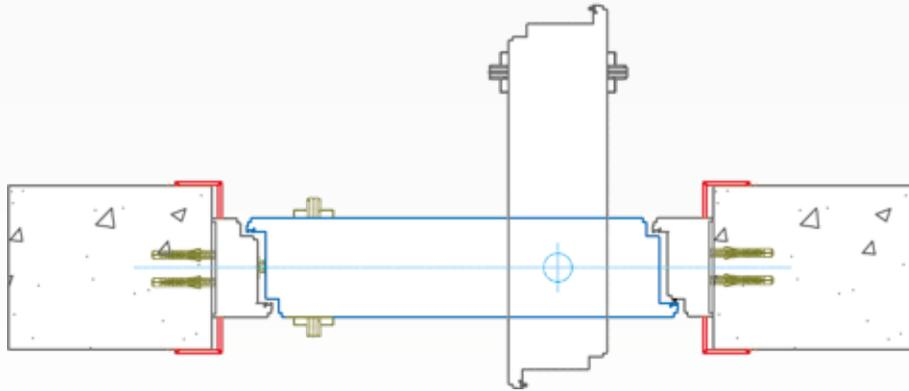

For the installation of the casing system (highlighted in red in the drawing above), space is required to glue it. Check out its main features:

- Standard sheets with maximum measurements of 5000 mm in height (the casing is not installed in larger spans due to necessary seams).
- Standard casing with 80 mm.
- Exclusive system with adjustment and alignment channel, where any imperfection in the wall is corrected, eliminating the use of silicone in the installation.

## System without casing

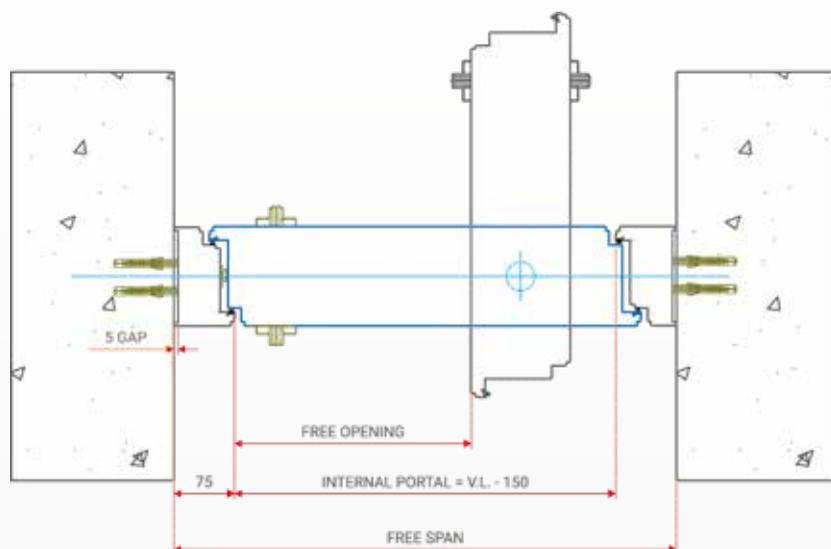

According to the drawing above, in this case, there is no space for installing the casing system. To eliminate the gap between the portal and the wall, an ACM tape (in the same color as the door) is installed, thus correcting and eliminating the use of silicone in the installation.

# External HANDLES

Available door models

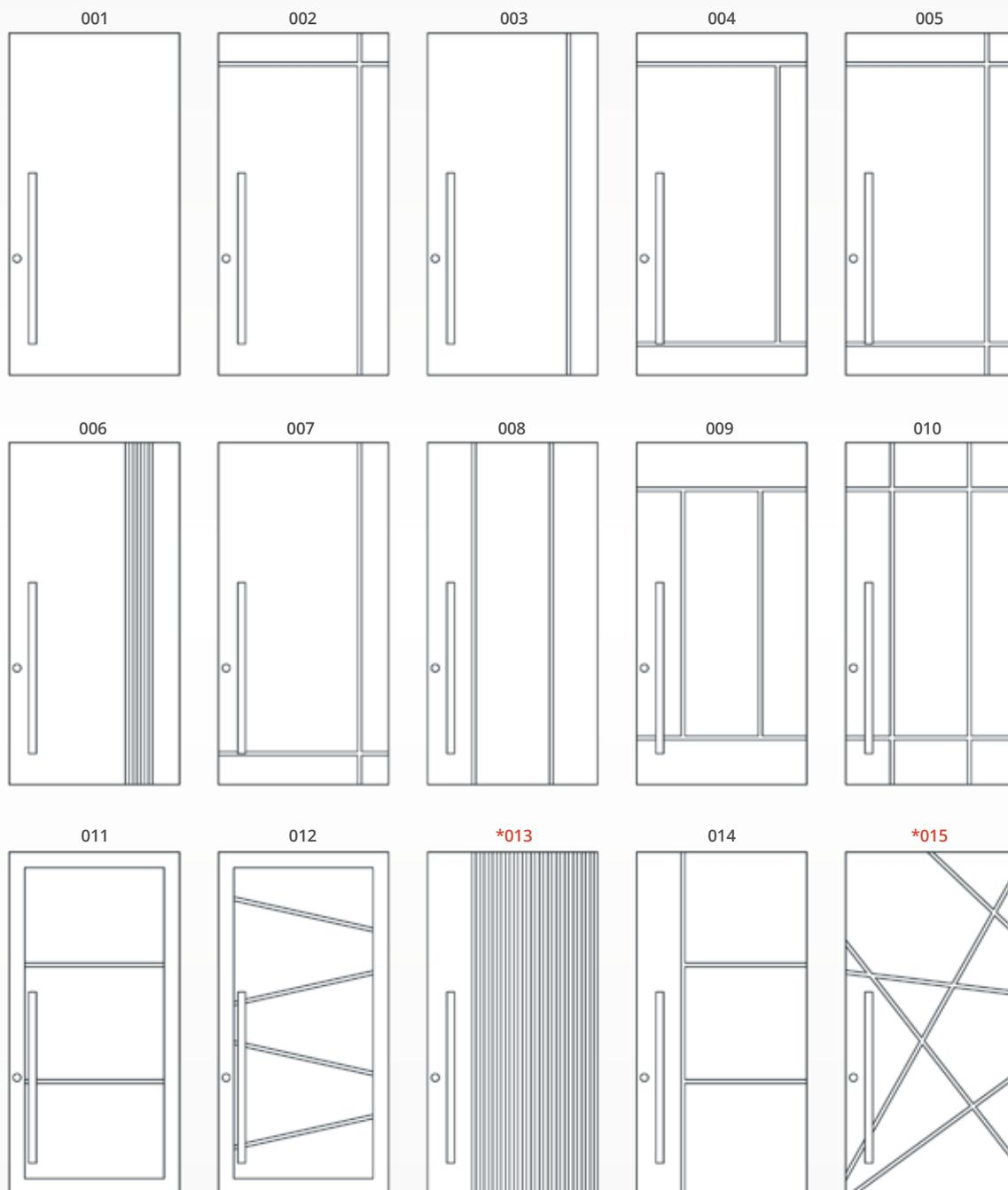

**NOTE:** Pay attention to the height and width limits of the boards. Dimensions: 1500 x 5000 mm.  
External handle in 304 stainless steel, price upon request. \*Models 013 and 015 have a special price.





# Pocket HANDLES

Available door models

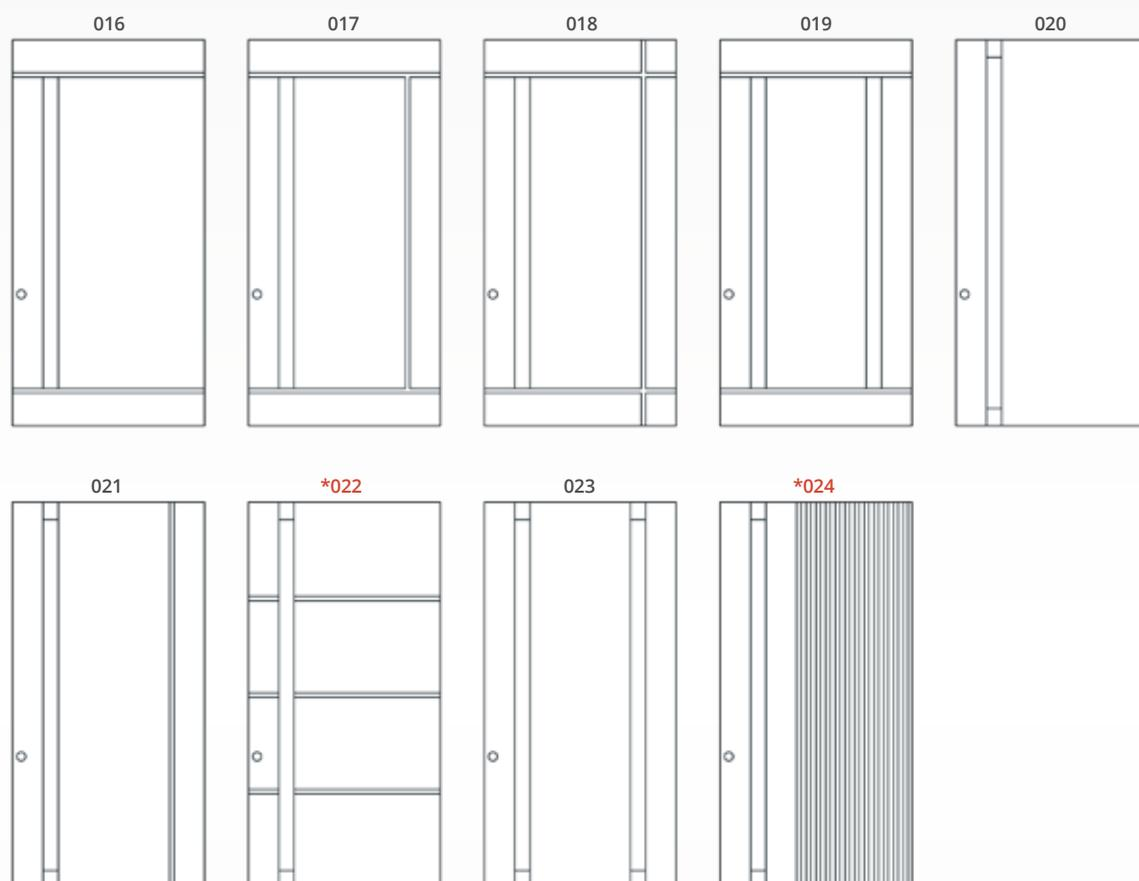

**NOTE:** Pay attention to the height and width limits of the boards. Dimensions: 1500 x 5000 mm.  
Pocket handle, price upon request. \*Models 022 and 024 have a special price.

Portfolio

**ULTRA DOOR**

Your  
home's  
business  
card.





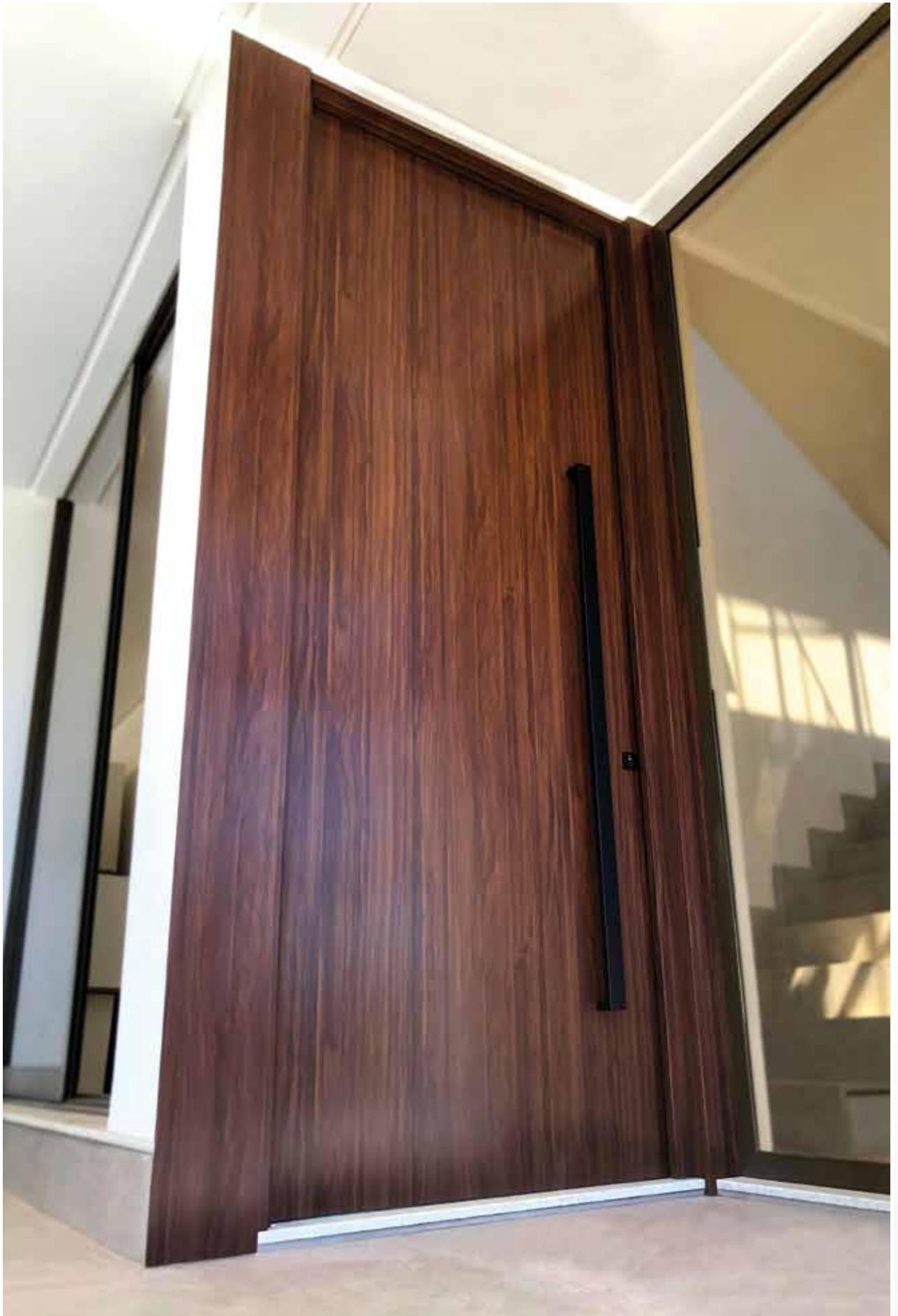

Portfolio

**ULTRA DOOR**



Portfolio



Projetta  
exclusive  
doors,

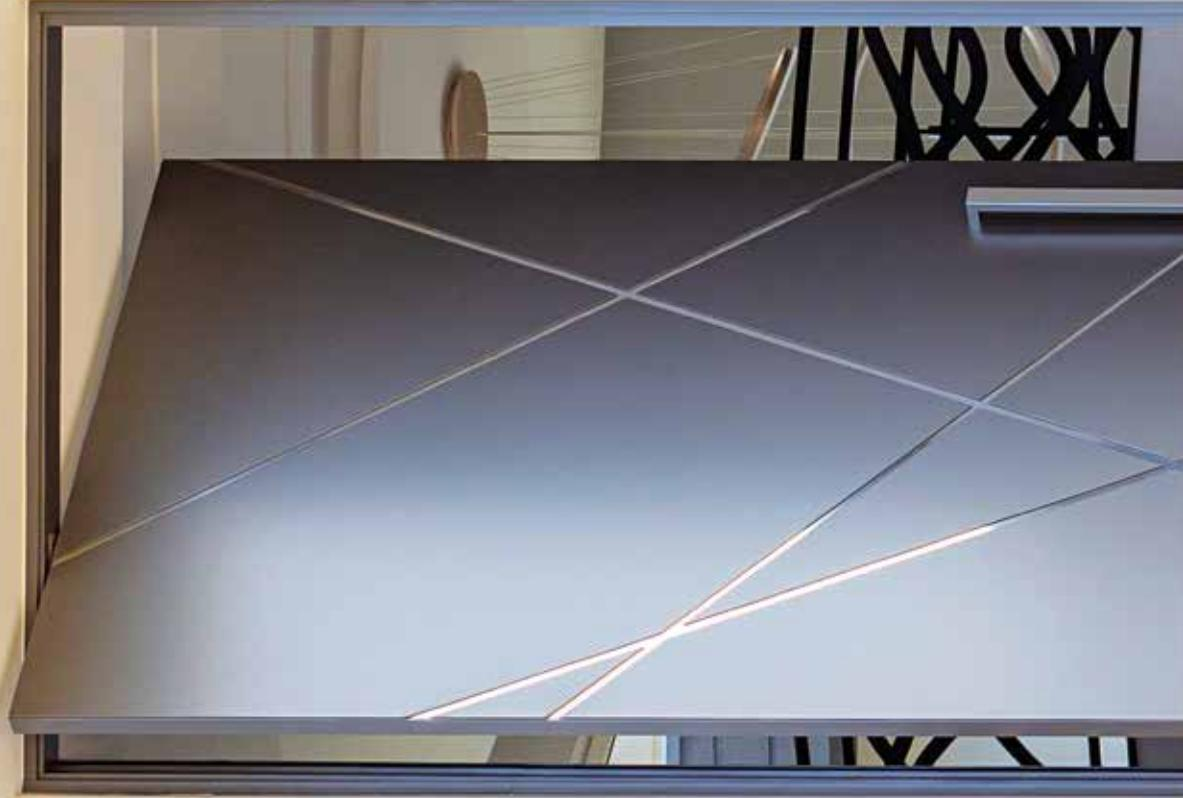

in the size  
of your  
dreams.



Portfolio

**XL DOOR**

Doors  
with the  
size your  
design  
deserves.



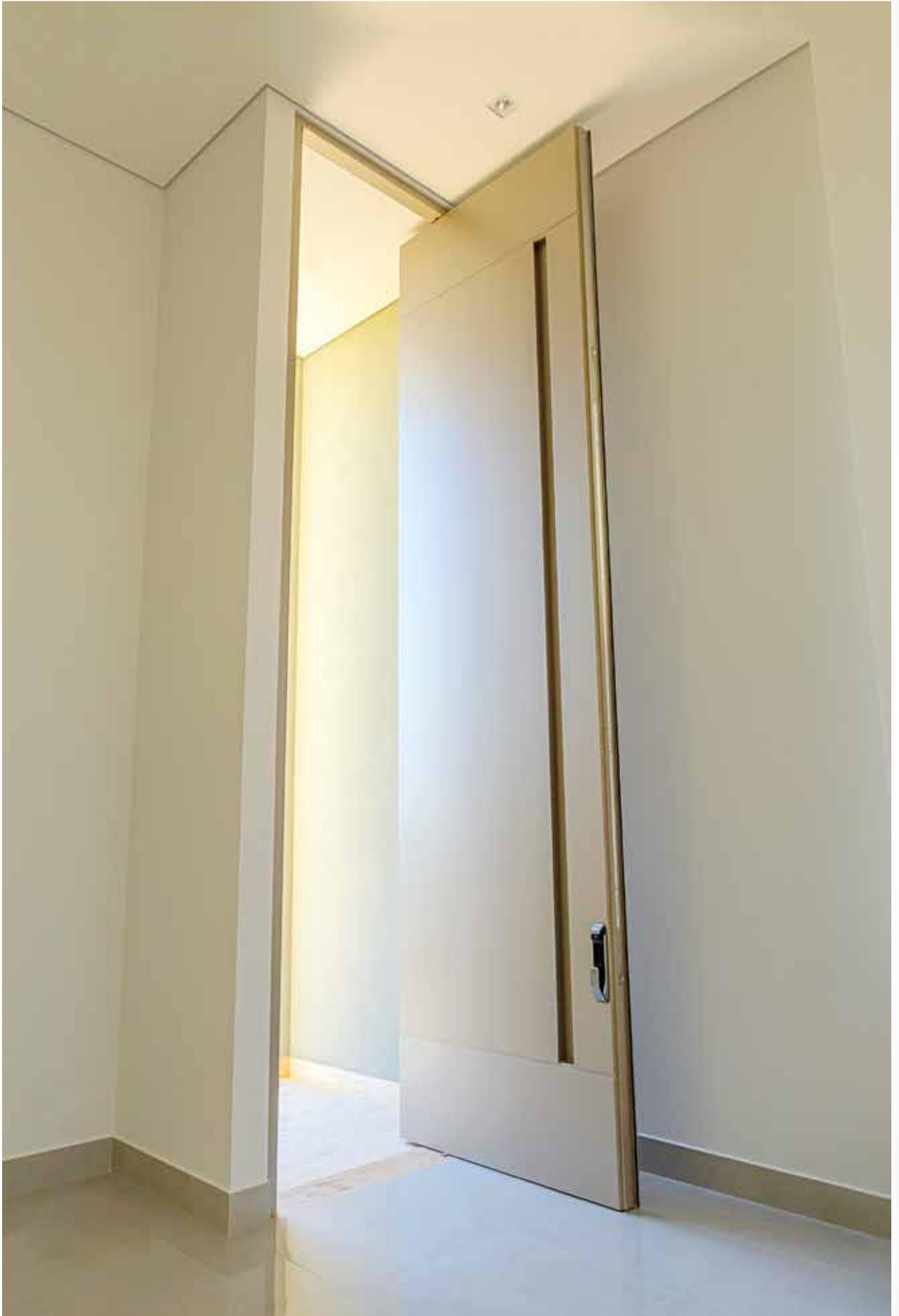

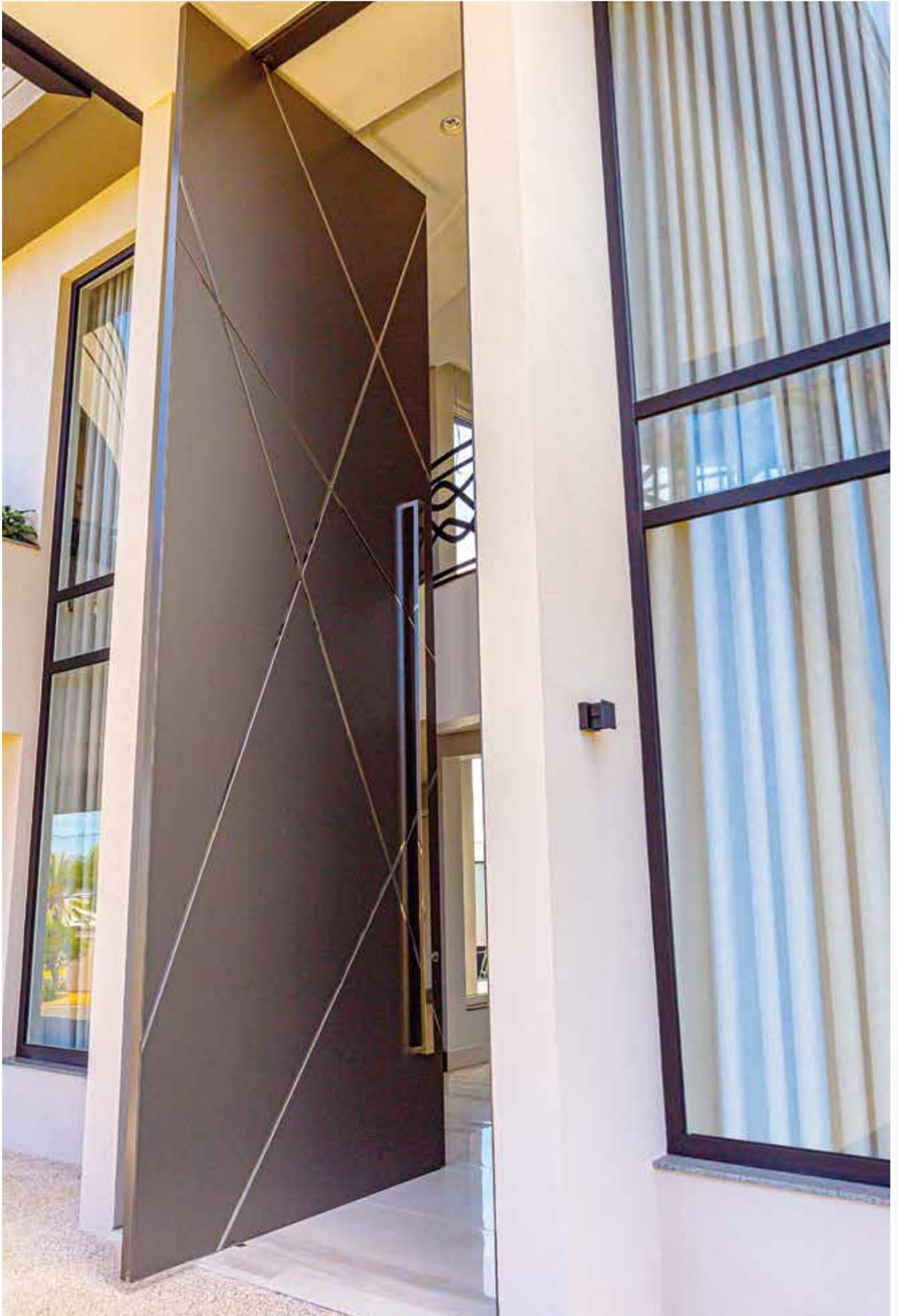

Portfolio

**XL DOOR**



Portfolio

**XL DOOR**





Portfolio XL DOOR

# The coating of your door

## MEET ACM

### What is ACM

Composite Aluminum Material - ACM is a painted aluminum coating, composed of two aluminum sheets with a low density polyethylene thermoplastic core. It uses a sophisticated gluing process, which involves several adhesives at high temperatures. The painted surface of the aluminum sheet is coated with PVDF KYNAR 500 (70%) or polyester base. The result is a product with excellent uniformity, strength, and beauty, used for covering façades, pillars, canopies, totems, logos and much more.

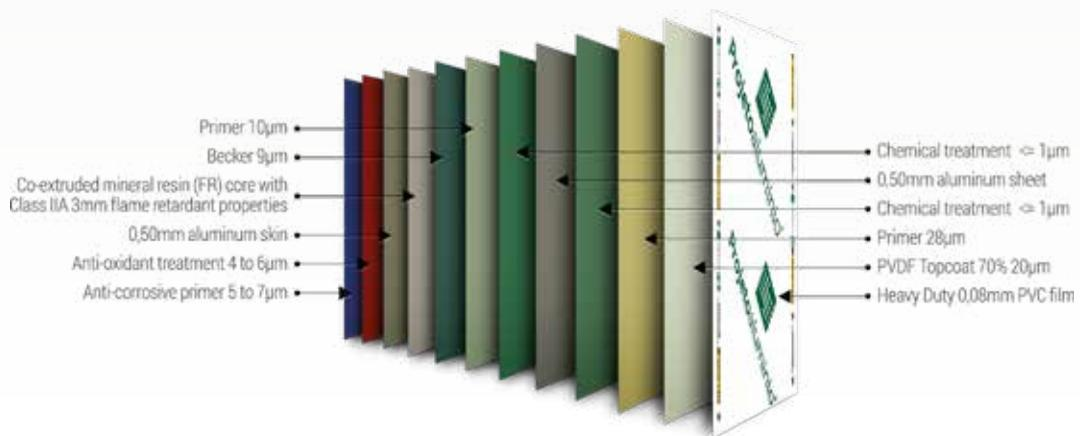

### Applications

ACM has several applications. As it is a material with great static appeal and easy handling, it allows the design professional to freely use his/her creativity. Please find below are some application examples:

- Coating of building facades, columns, beams, indoor areas and furniture.
- Signs, displays, signs, fair stands and kiosks.
- Gas station fronts, ceilings and partitions.

### Benefits

ACM sheets are sold in a wide variety of colors and textures. They provide unparalleled beauty, high durability, quick installation, ease of handling and cleaning.

- Low weight reducing its structural load.
- Possibility of manufacturing special colors or measures, upon minimum batch.
- Possibility of manufacturing with flame resistant mineral core (Class II-A).
- Flat surface guarantee, even in larger dimensions.
- Stiffness with excellent weight/strength ratio.
- They may be bent or curved using suitable tools.
- Paints with varied resins, which ensure strength and durability.
- Stability with better thermal and acoustic performance.

### Warranty period

Aluminum composite panels will have paint guarantees for a period of fifteen (15) years, when KYNAR resin is used.

# Color samples

## SOLID / SEMI-GLOSS



**NOTE:** Some Proietta color options may be similar to Weiku do Brasil profiles.  
Color samples may vary depending on the characteristics of the screen or graphic print.

# Color samples METALLIC

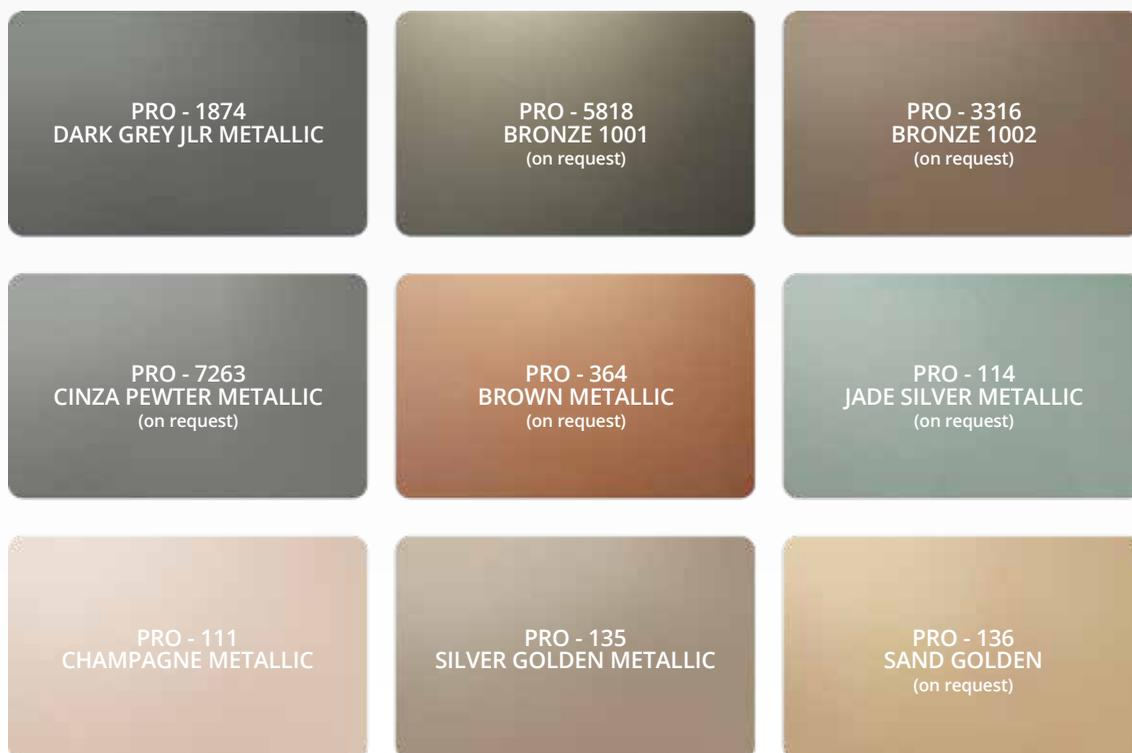

**NOTE:** Some Projetta color options may be similar to Weiku do Brasil profiles.  
Color samples may vary depending on the characteristics of the screen or graphic print.

# Color samples WOODEN



# Color samples SPECIAL



NOTE: Some Projetta color options may be similar to Weiku do Brasil profiles.  
Color samples may vary depending on the characteristics of the screen or graphic print.



# Accessories

## LOCKS

### Various types and models to choose from

From the simplest to multipoint models, with 24-pin lock. Digital locks may be installed, opening by code, card or fingerprint.

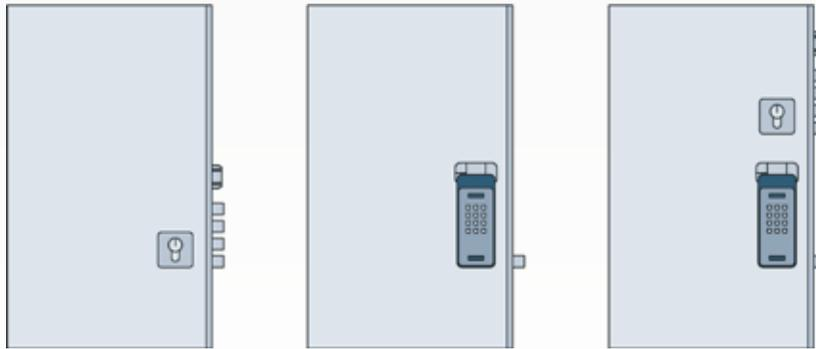

### Digital locks



**NOTE:** We do not guarantee any digital locks, whether purchased by the customer or not. Only locks with central locking may be used on our doors, in case of doubt, please contact us.

# Accessories LOCKS

## KESO - Multipoint

Currently, safety is very important to our customers. For this reason, we offer KESO multipoint locks from 4 to 24 points - with computerized keys. Moreover, our strikes and deadbolts are made of stainless steel 304 with Swiss technology, bringing much more security.



# Accessories HANDLES

Made of 304 stainless steel



- Metalon handles 50 x 30 mm.
- Available finishes: Black / Polished / Brushed.
- Available measures: 1500 mm Standard / 2000 mm / 3000 mm / 4000 mm / 5000 mm.
- Other dimensions on request.

# Accessories

## SEALS

### Door Seals

For a more efficient sealing, we use an automatic system at the bottom and top of the door that is activated when it closes. This system prevents dust, water and insects from coming in.

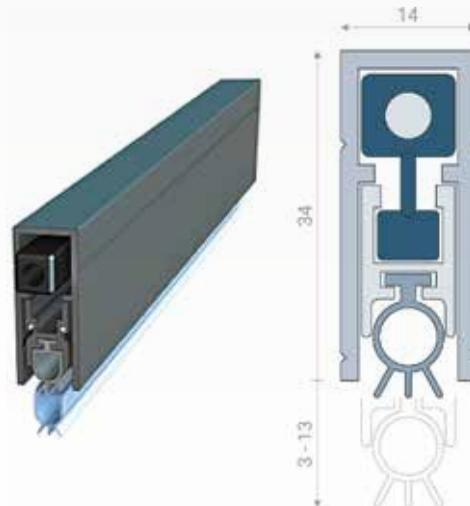

### Q-LON

Our doors and doorstop (jamb) contain an exclusive profile designed to receive the Q-LON - high performance sealing system, imported directly from Europe and widely used in frames that require thermal, acoustic and excellent tightness solutions.



### Main features and advantages:

- Materials with low conductivity property for high energy savings.
- Contamination resistant PE coating.
- Highly elastic PU foam with good recovery in all temperature ranges.
- Excellent thermal and acoustic performance.
- Rigid insert for easy adjustment and stability.
- Wide color range.

Design,  
technology,  
safety and  
exclusivity  
for your  
home.



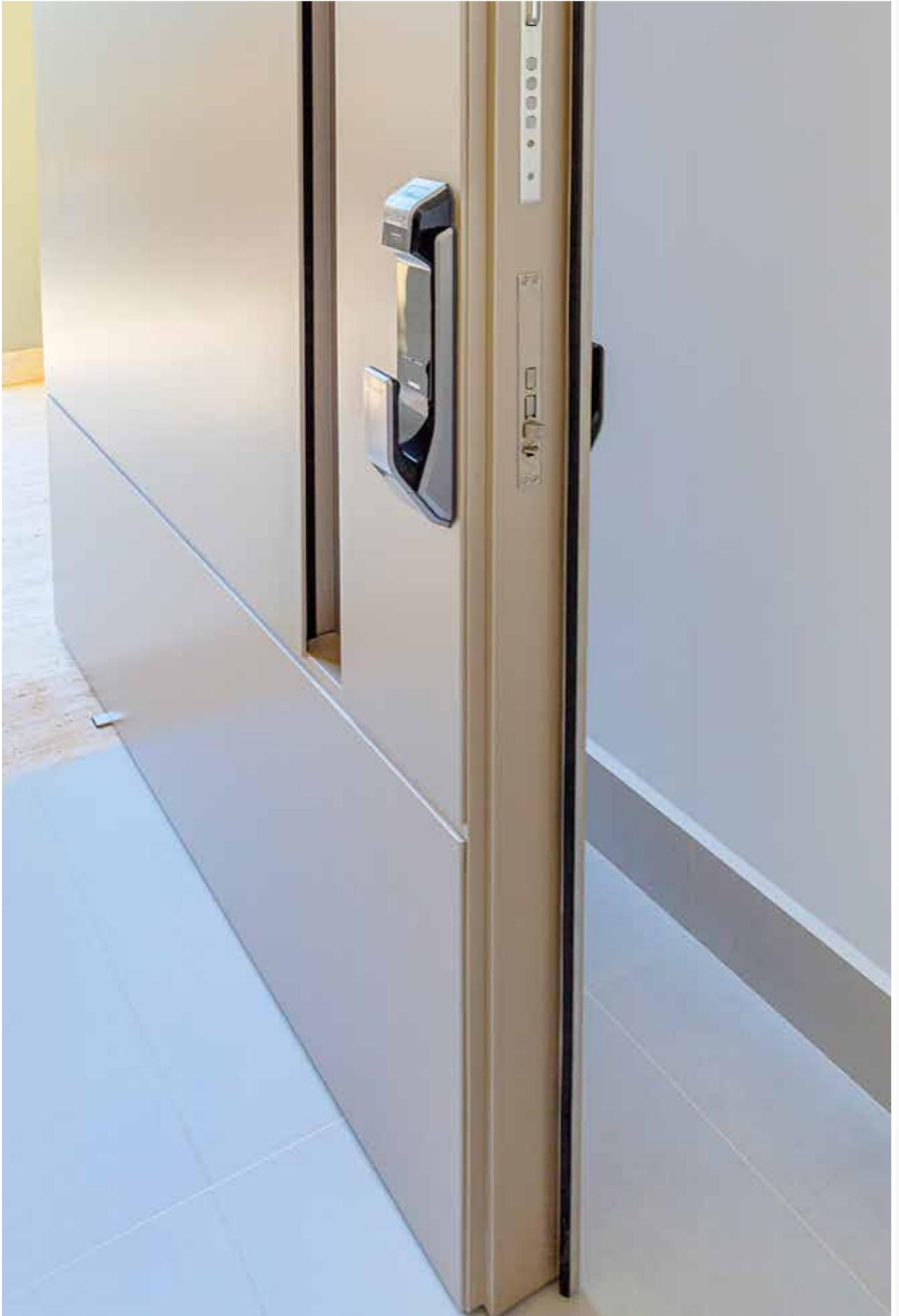

# Exclusive Doors



## Headquarters Pomerode, Santa Catarina

+55 (47) 3387-7500 - 0800 645 2644

Rua Hermann Koch, 261

Bairro Testo Central

CEP 89107-000

## Campinas Branch, São Paulo

+55 (19) 3234-2777

Rua Fernando Baron, 475

Bairro Recanto Fortuna

CEP 13082-573

 [weiku.com.br](http://weiku.com.br)



[weikudobrasil](#)

## Branch (Parque Fabril) Uberlândia, Minas Gerais

+55 (34) 3238-6491

Avenida dos Siquierolis, 51

Bairro Nossa Senhora das Graças

CEP 38401-708

 [projettaaluminio.com](http://projettaaluminio.com)



[projettaaluminio](#)

NOTE: Technical data subject to change without notice. Copyright reserved.

Your PROJETTA by WEIKU expert: